

UNI EN ISO 16120-2 steel flexible shaft multilayer made for clockwise and anticlockwise power transmission

Code	Ø shaft mm	Torsion		Torque		Bending radius mm	Weight gr/m
		Right degrees	Left degrees	Clockwise N cm	Anticlockwise N cm		
FAP04	4	90	80	105	50	55	90
FAP04SIN	4	80	90	50	105	55	90
FAP05	5	60	60	150	80	60	120
FAP05SIN	5	60	60	80	150	60	120
FAP06	6	55	55	300	100	70	190
FAP06SIN	6	55	55	100	300	70	190
FAP07	7	40	45	350	150	80	250
FAP07SIN	7	45	40	150	350	80	250
FAP08	8	30	40	450	230	90	340
FAP08SIN	8	40	30	230	450	90	340
FAP10	10	20	30	650	500	130	500
FAP10SIN	10	30	20	500	650	130	500
FAP12	12	15	30	850	550	160	700
FAP12SIN	12	30	15	550	850	160	700
FAP15	15	6	12	1200	600	300	1100
FAP15SIN	15	12	6	600	1200	300	1100
FAP20	20	8	6	1800	1100	400	1800
FAP20SIN	20	6	8	1100	1800	400	1800

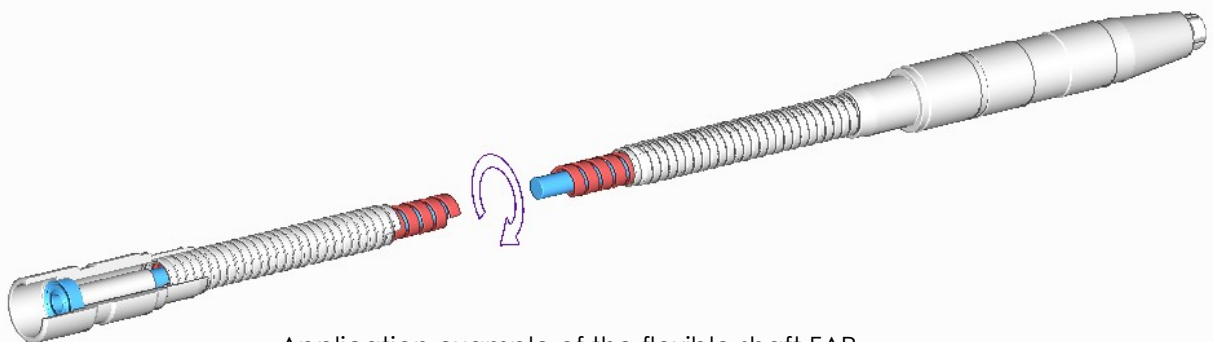

Application example of the flexible shaft FAP

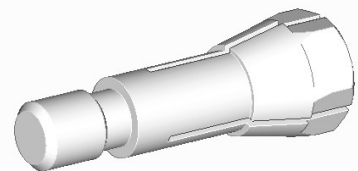
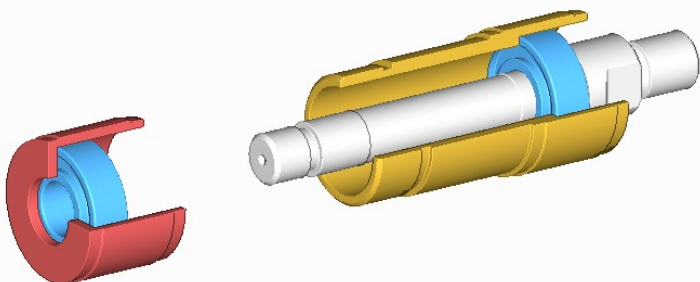
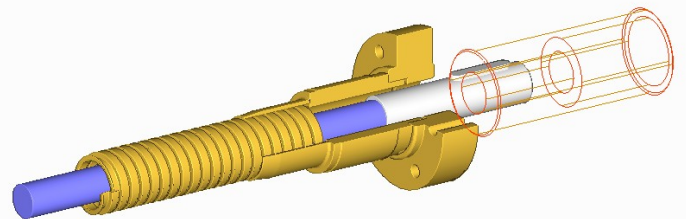
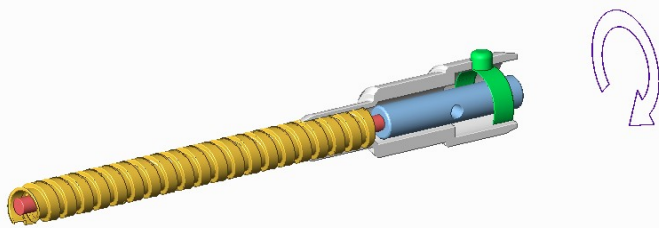
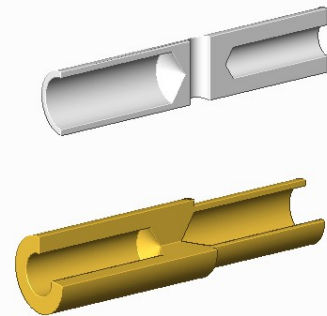
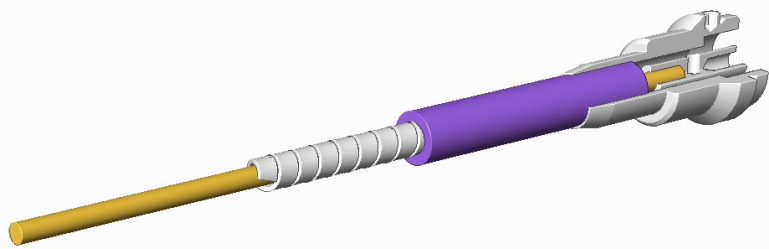

sales@ommcitalflex.com

OMMC ITALFLEX Srl
Via Pian di Rocco, 22
16042 Carasco (Ge)
ITALY

Ph. +39 0185 350231 | Fax +39 0185 351240
www.ommcitalflex.com